

Initial configuration

Vega 50 8 FXS + 2 FXO (SIP) – R5.2



This document describes how to configure the Vega 50 8 FXS + 2 FXO SIP gateway unit using the web browser interface. The configuration described here will allow the Vega to be rapidly installed and tested.

The instructions below will configure the Vega 50 8 FXS + 2 FXO to operate as follows:

- Calls made by any of the attached analogue phones will be routed to the SIP proxy; the Vega will pass on any dialled digits in the number part of the request URI
- Calls received from the PBX (on the FXO ports) will be routed to the SIP Proxy with the numeric telephone number part of the request URI containing the DN (directory number) for the port on which the call was received.
- Calls received from the SIP proxy with a leading 9 in the dialled number will be routed out of the first FXO port

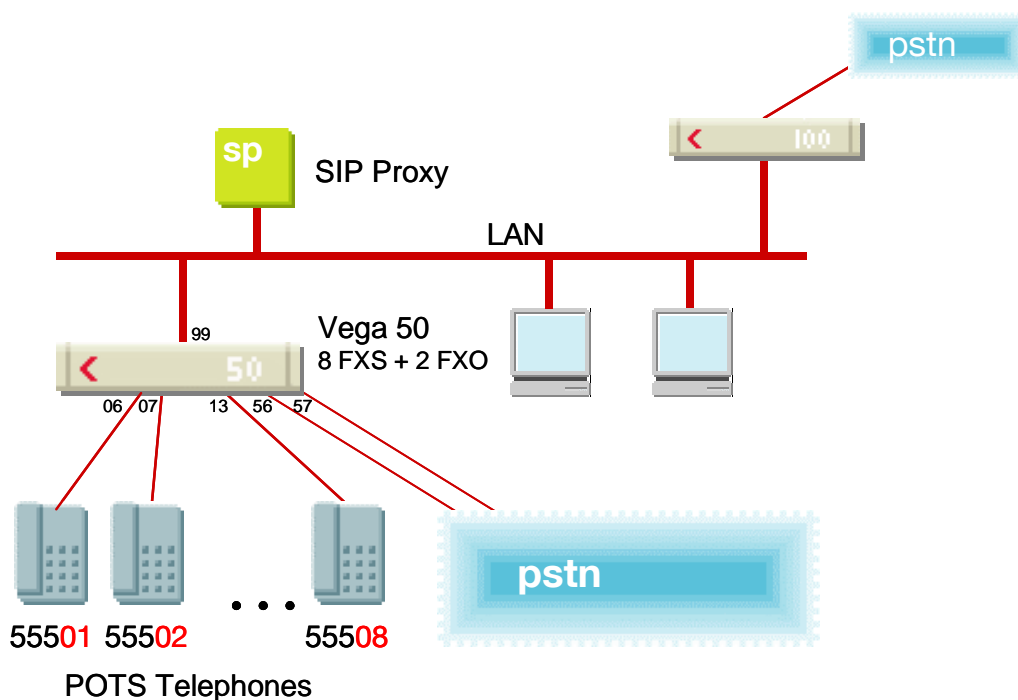

- Calls received from the SIP proxy with a leading 8 in the dialled number will be routed out of the second FXO port
- Calls received from the SIP proxy destined for the attached telephones must have a 2-digit “dialled number”, 06 to 13, to identify which of the 8 telephones to ring. (The translation of the telephone number to the 2-digit dialled number is carried out in the SIP proxy as the Vega registers the 2-digit dialled numbers against the user access numbers (registered addresses).)

The configuration process is broken down into 12 stages as follows:

- 1 Connect your Vega to LAN, telephones and Power
- 2 Configure the basic LAN parameters
- 3 Configure password and login timeout
- 4 Check and configure LAN settings and Host name
- 5 Configure the Dial Plan
- 6 Configure SIP and audio parameters
- 7 Configure Authentication
- 8 Configure Registration
- 9 Configure POTS parameters
- 10 Configure pointer to CD ROM documentation
- 11 Save Changes
- 12 Archive Vega Configuration

Please also see:

- 13 Technical Support

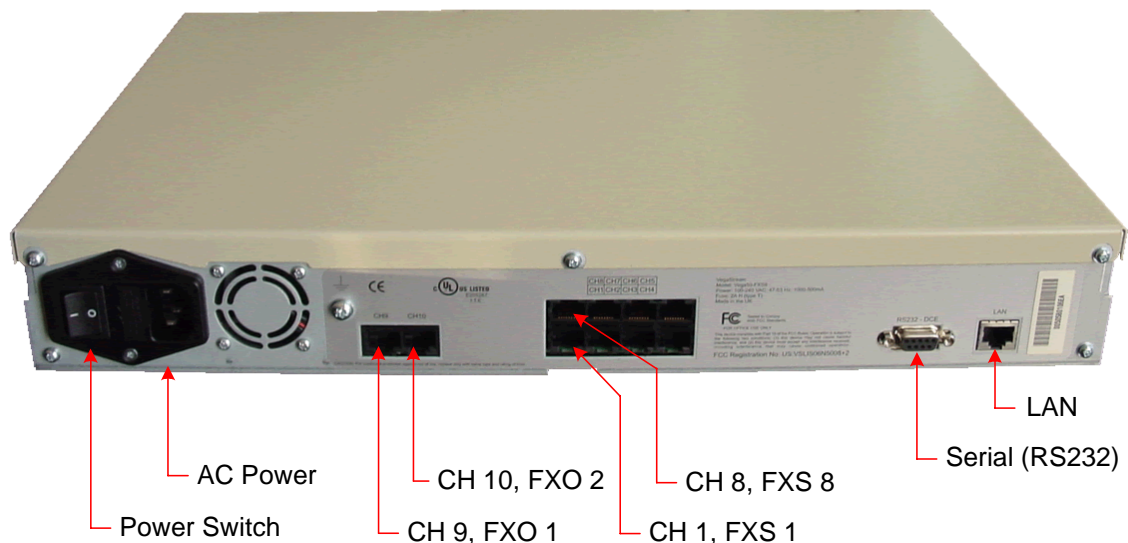

Before installing your Vega, ensure that you read the VegaStream VoIP Gateways Safety and Compliance Information document.

LAN:

Using the yellow booted cable connect the LAN port on the Vega to a standard or fast Ethernet hub or switch (10 baseT or 100 baseTx). The connector nearest the ferrite core should be plugged into the Vega.

Telephony:

Connect telephones to FXS ports 1 to 8. Note the port numbers increase in an anticlockwise direction from the bottom left corner.

FXO 1 IF: 56	FXO 2 IF: 57	FXS 8 IF:13	FXS 7 IF:12	FXS 6 IF:11	FXS 5 IF:10
		FXS 1 IF:06	FXS 2 IF:07	FXS 3 IF:08	FXS 4 IF:09

Telephone lines can be connected to the two FXO ports.

Power:

Insert the power cable into the AC power inlet on the Vega and switch on. The power LED on the front panel will illuminate.

The LAN LEDs will also illuminate indicating 10 (baseT) or 100 (baseTx) connection, and the FDX LED will illuminate if Full Duplex mode has been negotiated.

2. Configure the basic LAN parameters

If a DHCP server is available, by default, the Vega will automatically pick up an IP address. If you know the IP address served to the Vega, skip this section and start at section [3](#).

If DHCP is not to be used to provide the Vega with an IP address, or you need to check the IP address provided to the Vega, connect the serial interface of the Vega to a PC serial interface using a 9 way male to female straight through cable.

Configure a terminal emulator program (such as Microsoft's HyperTerminal) for:

- Speed = 115200 baud
- Data bits = 8
- Parity = none
- Stop bits = 1
- Flow Control = none

Press <Enter> to get the Username: prompt

At the prompts enter the default user name and password

Username: admin

Password: admin

To display the current IP address, type:

➤ show lan.ip

If this is not the IP address required, it can be overridden, together with other LAN parameters by typing:

- set lan.use_dhcp=0
- set lan.ip=aaa.bbb.ccc.ddd
- set lan.subnet=eee.fff.ggg.hhh
- set lan.gateway=iii.jjj.kkk.lll
- save
- reboot system

3. Configure password and login timeout

Now configuration will be carried out using a web browser.

- Enter the IP address of the Vega into the “Address” field of your web browser.

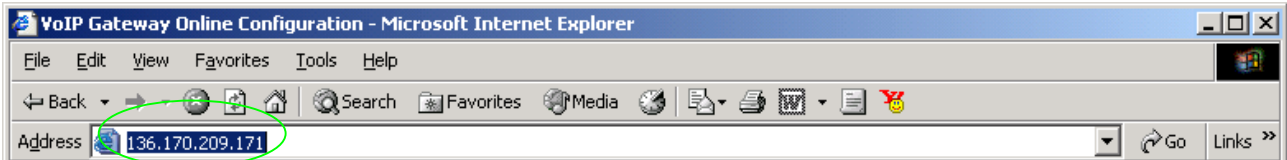

You will then be presented with the login page:

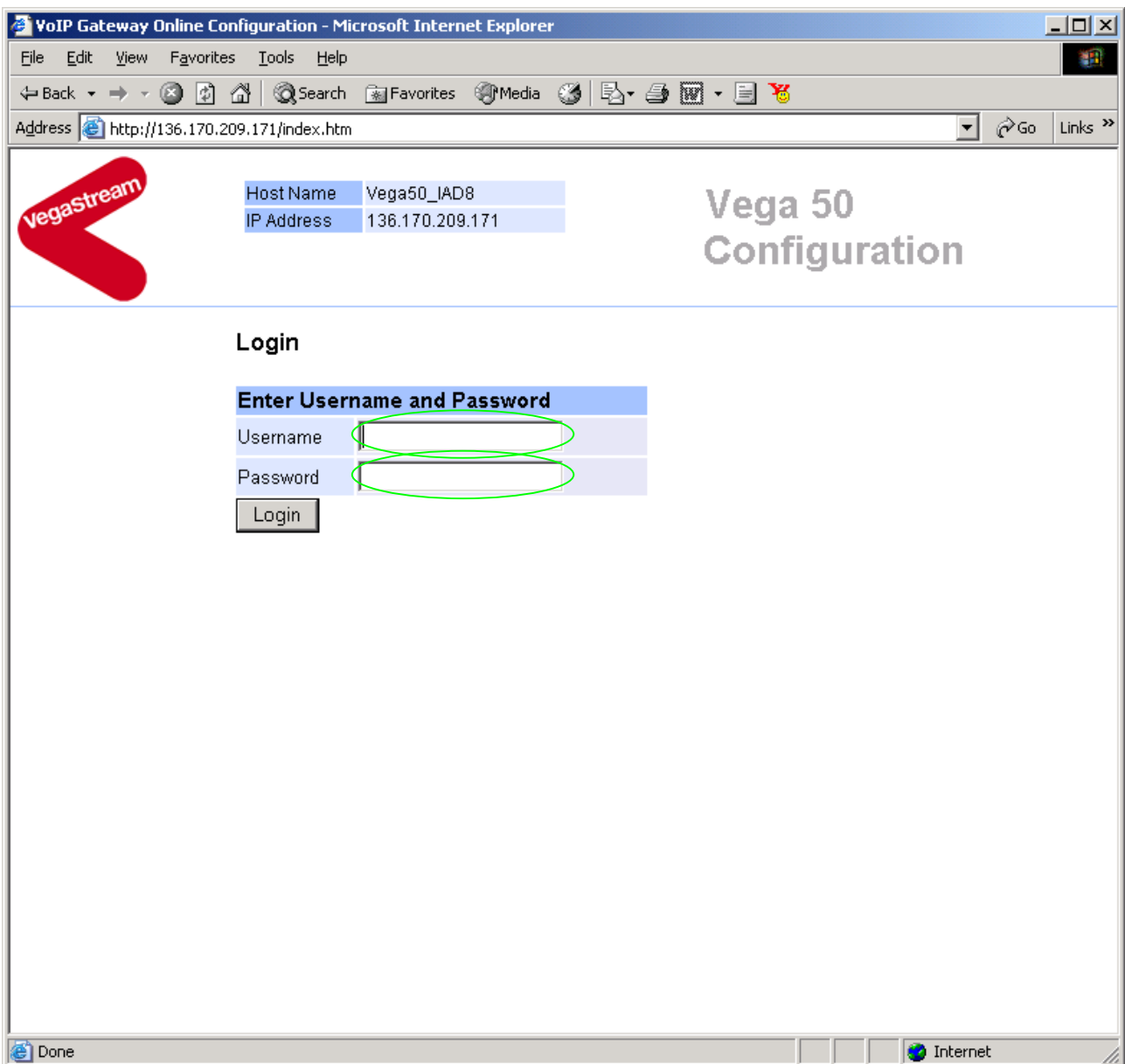

Enter the default Username and Password

- Username: admin
- Password: admin
- Select

Vega 50 Configuration

Host Name	Vega50_IAD8
IP Address	136.170.209.171
User Name	admin

Management

- Logging
- Maintenance
- LAN
- POTS
- Dial Plan
- Media Channels
- Tones
- SIP
- Users**
- QoS
- Advanced

Save
Log off
Help
Reboot System

System Management

Tip: Place the cursor of the mouse on name or input fields to get concise help.

Quick Configuration Wizard

Quick step by step essential configuration

System Time

Set Time (hh:mm:ss) : :

Set Date (dd/mm/yyyy) / /

Synchronise Time and Date With PC With NTP server

Call Reports

Report call progress summary [Show Calls](#)

Report on all call progress statistics [Show Trace](#)

System Logs

Show the Event Log [Show Event Log](#)

Show the Billing Log [Show Billing Log](#)

Call Control

- On the left hand side menu select [Users](#)

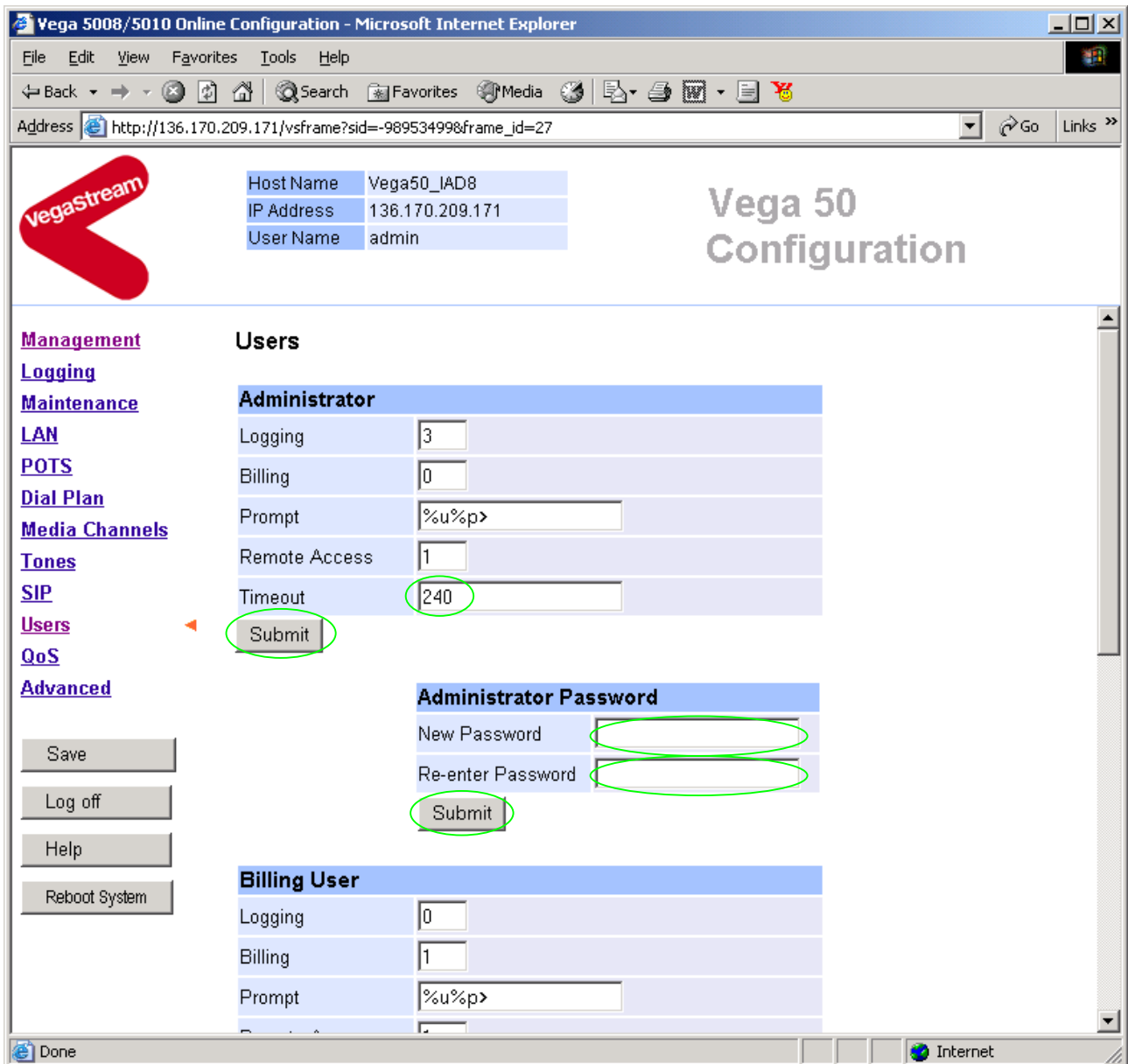

Recommended: Change the password

- enter New Password and Re-enter Password then
- select and then click "[here](#)" to return

Optional: Change the timeout¹ – default is 240 seconds; can extend to 7200 seconds (2hrs)

- select and then click "[here](#)" to return

¹ If the web interface is not used for this length of time the Vega will automatically log off the session. This change is only activated by logging out and back into the web browser session.

4. Check and configure LAN settings and Host name

- On the left hand side menu select [LAN](#)
- Scroll down to see both **LAN Configuration** and **Physical layer Configuration** sections

Vega 5008/5010 Online Configuration - Microsoft Internet Explorer

File Edit View Favorites Tools Help

Address http://136.170.209.171/vsframe?sid=-232186483&frame_id=1 Go Links >>

VegaStream

Host Name Vega50_IAD8
IP Address 136.170.209.171
User Name admin

Vega 50 Configuration

Unsaved Configuration Changes

Management
Logging
Maintenance
LAN
POTS
Dial Plan
Media Channels
Tones
SIP
Users
QoS
Advanced

Save
Log off
Help
Reboot System

LAN Configuration

Use DHCP
Host Name Vega50_IAD8
IP Address DHCP defined
Subnet Mask DHCP defined
Domain Name Server DHCP defined Use DHCP
Default Gateway DHCP defined Use DHCP
TFTP Server DHCP defined Use DHCP
Network Time Server DHCP defined Use DHCP
FTP Server 0.0.0.0
NTP Offset (hhmm) 0000
NTP Poll Interval 0

Physical Layer Configuration

Full Duplex
Ethernet Type 10baseT & 100baseTX
QoS profile 1

Submit

Done Internet

Recommended: In the **Physical Layer Configuration** section statically select the Ethernet Type as either 100baseTx or 10 baseT – whichever is appropriate – (not 10baseT & 100baseTx autoselection)

- select and then click ["here"](#) to return

Recommended: In **LAN Configuration** section set up

- Network Time Server = IP address
- NTP Offset = time offset from UTC (GMT)
- NTP Poll Interval = 2400

- select and then click "[here](#)" to return

Optional: If there are any LAN values that need to be set up manually, set them up now (e.g. tftp and ftp addresses), then

- Select and then click "[here](#)" to return

5. Configure the Dial Plan

➤ On the left hand side menu select [Dial Plan](#)

Host Name Vega50_IAD8
IP Address 136.170.209.171
User Name admin

Vega 50 Configuration

Management
[Logging](#)
[Maintenance](#)
[LAN](#)
[POTS](#)
[Dial Plan](#) ◀
[Media Channels](#)
[Tones](#)
[SIP](#)
[Users](#)
[QoS](#)
[Advanced](#)

Save
Log off
Help
Reboot System

Dial Planner

Profiles

Del?	Profile ID	Enabled	Name	Plans	Chg?
<input type="checkbox"/>	1	1	Vega50_IAD-8	==>	Modify

Delete Add

Planner Groups

Del?	ID	Name	Cause	Lan	Gatekeeper	Active times	Priority	Chg?
<input type="checkbox"/>	1	LAN_Up	0	active	off	0000-2359	0	Modify
<input type="checkbox"/>	2	LAN_Down	0	inactive	off	0000-2359	0	Modify

Delete Add

Planner Whitelist Enable

Use Whitelist

Submit

Planner Whitelists

Del?	ID	Name	Number	Chg?
<input type="checkbox"/>	1	default	IF:.*	Modify

Delete Add

Firstly, turn off the default profile:

In the **Profiles** section

➤ Select [Modify](#)

[Dial Planner](#) > Profile 1

Modify Profile	
Profile ID	1
Enabled	<input checked="" type="checkbox"/>
Name	Vega50_IAD-8
<input type="button" value="Submit"/>	

- disable (un-tick) Enabled, then
- select and then click "[here](#)" to return

Now create a new profile and in it create a dial plan entry to handle calls being sent outbound on the LAN:

Dial Planner

Profiles					
Del?	Profile ID	Enabled	Name	Plans	Chg?
<input type="checkbox"/>	1	0	Vega50_IAD-8	====>	Modify
<input type="button" value="Delete"/>	<input type="button" value="Add"/>				

In the **Profiles** section

- Select

Dial Planner

Profiles					
Del?	Profile ID	Enabled	Name	Plans	Chg?
<input type="checkbox"/>	1	0	Vega50_IAD-8	====>	Modify
<input type="checkbox"/>	2	1	new_profile	====>	Modify
<input type="button" value="Delete"/>	<input type="button" value="Add"/>				

In the **Profiles** section, on Profile 2 (the new profile):

- Select [Modify](#)

[Dial Planner](#) > Profile 2

Modify Profile	
Profile ID	2
Enabled	<input checked="" type="checkbox"/>
Name	new_profile
<input type="button" value="Submit"/>	

Plans in this Profile							
Del?	Plan ID	Name	Src	Dest	Cost	Group	Chg?
<input type="checkbox"/>	1	new_plan	TEL:<.><.*>	IF:<1>,TEL:<2>	0	0	Modify
<input type="button" value="Delete"/>	<input type="button" value="Add"/>						

- Set Name = Outbound_To_LAN
- select and then click "[here](#)" to return

Dial Planner

Profiles						
Del?	Profile ID	Enabled	Name	Plans	Chg?	
<input type="checkbox"/>	1	0	Vega50_IAD-8	====>	Modify	
<input type="checkbox"/>	2	1	Outbound_To_LAN	====>	Modify	

In the **Profiles** section, on Profile 2 (the new profile):

- Select

Plans in this Profile							
Del?	Plan ID	Name	Src	Dest	Cost	Group	Chg?
<input type="checkbox"/>	1	new_plan	TEL:<.><.*>	IF:<1>,TEL:<2>	0	0	Modify

In the **Plans in this Profile**, Plan ID 1:

- Select

Host Name Vega50_IAD8
IP Address 136.170.209.171
User Name admin

Unsaved & Unapplied Changes

Vega 50 Configuration

Management
Logging
Maintenance
LAN
POTS
Dial Plan
Media Channels
Tones
SIP
Users
QoS
Advanced

Dial Planner > Profile 2 > Plan 1

Modify Plan



Plan ID	1
Profile ID	2
Name	new_plan
Source	TEL:<.><.*>
Destination	IF:<1>, TEL:<2>
Cost Index	0
Group	0 - no group

Apply Generate Prefix Match

Regular Expressions for Source

.	Any character
[...]	Any character within the parentheses
[x-y]	Any character in the range x-y
[^...]	Any character except those within the parentheses
*	The character before repeated zero or more times
+	The character/expression before repeated one or more times
?	The character/expression before repeated zero or more times
\	The character following is taken literally
< >	Capture the sequence in parentheses and store as < n > where n is

Save
Log off
Help
Reboot System
Apply Changes

- Set Name = Any_Tel_Port
- Set Source = IF: [^9] . , TEL: < . * > *(This takes a call from any of the telephony ports; FXS ports store the number dialled in store <1>, FXO ports store their "DN" in store <1>)*
- Set Destination = IF: 99 , TEL: < 1 > *(This routes the call to IF:99 (the SIP proxy) and passes on the dialled number (FXS) or "DN" (FXO) as the dialled digits)*
- Select  and then click "[here](#)" to return
- Select  ... to return to the **Dial Planner Profiles** section

Now create a new profile and in it create a dial plan entry to handle calls being received inbound from the LAN:

In a similar manner to adding profile 2 add another profile, profile 3,

- Set Name = Inbound_from_LAN

Modify the first plan for Profile 3:

- Set Name = To_FXS_Tel_Ports
- Set Source = IF:99,TEL:<..> *(For calls from IF:99 (SIP), take the two digits presented as the telephone number and store them in store <1>)*
- Set Destination = IF:<1> *(Use the 2 digits in store <1> as the interface ID (telephone) to ring)*
- Select  and then click "[here](#)" to return

Plans in this Profile							
Del?	Plan ID	Name	Src	Dest	Cost	Group	Chg?
<input type="checkbox"/>	1	To_FXS_Tel_Ports	IF:99,TEL:<..>	IF:<1>	0	0	Modify
							

Add a new plan to Profile 3:

- Set Name = To_FXO_Port_1
- Set Source = IF:99,TEL:9<.*> *(For calls from IF:99 (SIP), where the leading digit is a 9, take any following digits presented as the telephone number and store them in store <1>)*
- Set Destination = IF:56,TEL:<1> *(Route the call to the first FXO port, and DTMF outdial any digits that were received after the 9)*
- Select  and then click "[here](#)" to return

Add a third plan to Profile 3:

- Set Name = To_FXO_Port_2
- Set Source = IF:99,TEL:8<.*> *(For calls from IF:99 (SIP), where the leading digit is an 8, take any following digits presented as the telephone number and store them in store <1>)*
- Set Destination = IF:57,TEL:<1> *(Route the call to the second FXO port, and DTMF outdial any digits that were received after the 8)*
- Select  and then click "[here](#)" to return

The profile 3 plans should look as follows:

Dial Planner > Profile 3

Modify Profile	
Profile ID	3
Enabled	<input checked="" type="checkbox"/>
Name	Inbound_From_LAN
<input type="button" value="Submit"/>	

Plans in this Profile							
Del?	Plan ID	Name	Src	Dest	Cost	Group	Chg?
<input type="checkbox"/>	1	To_FXS_Tel_Ports	IF:99,TEL:<.>	IF:<1>	0	0	Modify
<input type="checkbox"/>	2	To_FXO_port_1	IF:99,TEL:9<.*>	IF:56,TEL:<1>	0	0	Modify
<input type="checkbox"/>	3	To_FXO_Port_2	IF:99,TEL:8<.*>	IF:57,TEL:<1>	0	0	Modify
<input type="button" value="Delete"/> <input type="button" value="Add"/>							

Note 1: *The Relationship between physical ports and Interface Ids is as follows:*

FXS 1 = IF:06

FXS 2 = IF:07

...

FXS 8 = IF:13

FXO 1 = IF:56

FXO 2 = IF:57

SIP LAN = IF:99

Note 2: *The SIP proxy must choose the appropriate interface on the Vega to dial out from.*

When a call is presented to the Vega for an FXS port, the INVITE message starts something like:

```
INVITE sip:06@136.170.209.171 SIP/2.0
```

The digits preceding the @ are provided to the dial planner as the source TEL:. Hence in the dial plan above the calls coming from the LAN (IF:99) must have a 2-digit dialed number (whose value must be 06 ... 13 for valid Vega 50 interface IDs), which is used to define which telephone to ring.

When a call is presented to the Vega for an FXO port, the INVITE message starts something like:

```
INVITE sip:801344784900@136.170.209.171 SIP/2.0
```

The digits preceding the @ are provided to the dial planner as the source TEL:. Hence in the dial plan above this call with a leading "8" will be sent to FXO port 2 and the following digits "01344784900" will be DTMF outdialled on this port.

For more details on the operation of the dial planner, including the various tokens that may be used, see the section "The Dial Planner" in the Vega Primer.

6. Configure SIP and audio parameters

- On the left hand side menu select [SIP](#)

VegaStream

Host Name	Vega50_IAD8
IP Address	136.170.209.171
User Name	admin

Vega 50 Configuration

Unsaved Configuration Changes

Management
Logging
Maintenance
LAN
POTS
Dial Plan
Media Channels
Tones
SIP
Users
QoS
Advanced

SIP Configuration

General

Default Proxy Host Name/IP	0.0.0.0
Local Domain	vegastream.com
Local SIP Port	5060
Remote SIP Port	5060
Accept Non-Proxy Invites	<input type="checkbox"/>
QoS profile	0

Submit

Multiple Proxy Support

Mode	<input checked="" type="radio"/> normal	<input type="radio"/> cyclic
Minimum Valid Response	180	
Timeout (ms)	5000	

Backup Proxy	Enabled	IP/Name	Port	Chg?
1	1	0.0.0.0	5060	Modify
2	1	0.0.0.0	5060	Modify

Delete Add

Submit

In the **General** section:

- set Default Proxy Host Name/IP = IP_address_of_SIP_proxy, or DNS_hostname_of_the_SIP_Proxy
- set Local Domain =
Public_name_of_proxy_used_by_other_devices_to_send_their_INVITES_to
(this value is the "outside world's" name or IP address for the proxy)

Optional: To allow devices other than the proxy to make calls directly through the Vega

- tick Accept Non-Proxy Invites

If only the proxy is allowed to route the calls to the Vega ensure that this tick box is clear.

- select **Submit** and then click “[here](#)” to return
- Scroll down to the **Audio** section

Vega 50 Configuration

Host Name: Vega50_IAD8
 IP Address: 136.170.209.171
 User Name: admin

Unsaved Configuration Changes

Backup Proxy	Enabled	IP/Name	Port	Chg?
1	1	0.0.0.0	5060	Modify
2	1	0.0.0.0	5060	Modify

Audio

Audio Profile 1	G711 Ulaw
Audio Profile 2	None
Audio Profile 3	None
Audio Profile 4	None

Registration

Enable Registration	<input checked="" type="checkbox"/>
Register on Start-up	<input type="checkbox"/>
Registrar Host Name/IP	0.0.0.0
Registrar Remote Port	5060
Expiry Time (seconds)	600
Show SIP Registration	Show Registration

In the **Audio** section

- Select the audio codecs desired using the drop down menus

Unless there is a specific reason not to allow a specific codec to be used, it is recommended that all codecs should be enabled as follows:

Audio	
Audio Profile 1	G723
Audio Profile 2	G729
Audio Profile 3	G711 Ulaw
Audio Profile 4	G711 Alaw

- select and then click "[here](#)" to return

7. Configure Authentication

In some systems – to ensure that only authorised devices are allowed to set up and clear calls – SIP authentication is used. If authentication is used, it is typically required on the SIP REGISTRATION, INVITE, ACK and BYE messages.

For authentication, a userID and a password can be configured. The userID is constructed from three parts

`auth_usernumber_prefix`, `auth_usernumber` and `auth_usernumber_suffix` each of which may be configured with alphanumeric values.

The prefix and suffix entries are defined per POTS port profile and the `usernumber` is configured per POTS port. Setting parameters to NULL tells the Vega to omit anything from this parameter (capitalisation of NULL is important).

The values to enter here must match the values that have been configured as the authorisation user and password in the proxy.

To configure Authentication, follow the following procedure:

- On the left hand side menu select [SIP](#)
- Scroll down to the bottom of the page

VegaStream

Host Name: Vega50_IAD8
 IP Address: 136.170.209.171
 User Name: admin

Vega 50 Configuration

Unsaved Configuration Changes

SIP Signalling Transport	<input checked="" type="radio"/> udp <input type="radio"/> tcp
Reliable Provisional Responses	<input type="radio"/> supported <input type="radio"/> require <input checked="" type="radio"/> off
DTMF Transport	<input checked="" type="radio"/> rfc2833 <input type="radio"/> info <input type="radio"/> rfc2833 and tx info <input type="radio"/> off
DTMF INFO	<input checked="" type="radio"/> mode1 <input type="radio"/> mode2
RFC2833 payload (96-127)	96
Enable T38	<input checked="" type="checkbox"/>
Enable Fax	<input checked="" type="checkbox"/>
Fax Detect	<input type="radio"/> always <input checked="" type="radio"/> terminating
Signalling Application ID	none
T1 Retry Timer Increment (ms)	500
T2 Retry Timer Limit (ms)	4000
Interface ID	99
Cost	1
Maximum Calls	60

Save
Log off
Help
Reboot System

Advanced SIP Configuration

[Advanced SIP](#)

- Select [Advanced SIP](#)

Host Name Vega50_IAD8
IP Address 136.170.209.171
User Name admin

Vega 50 Configuration

Unsaved Configuration Changes

Management
[Logging](#)
[Maintenance](#)
[LAN](#)
[POTS](#)
[Dial Plan](#)
[Media Channels](#)
[Tones](#)
[SIP](#)
[Users](#)
[QoS](#)
[Advanced](#)

SIP > Advanced

Advanced SIP parameters

BYE-Also INVITE to proxy	<input type="checkbox"/>
REFER INVITE to proxy	<input type="checkbox"/>
Send CANCEL to all forks	<input checked="" type="checkbox"/>
User-Agent header	<input checked="" type="checkbox"/>
Use 'local domain' in To header	<input checked="" type="checkbox"/>
Use 'local domain' in From header	<input checked="" type="checkbox"/>
Use Request-URI in call dialog matching	<input type="checkbox"/>
183 Session Progress if media present	<input type="checkbox"/>
early OK timer (0=off)	<input type="text" value="0"/>
Use authentication users	<input checked="" type="checkbox"/>
Parse Remote Party-ID header	<input type="checkbox"/>

SDP control

Single media description in T38 INVITE	<input type="checkbox"/>
Connection information in session description only	<input type="checkbox"/>

SIP INFO messages

Transmit DTMF INFO messages	<input checked="" type="checkbox"/>
Transmit hookflash INFO messages	<input checked="" type="checkbox"/>

Save
Log off
Help
Reboot System

Submit

- Select (tick) Use authentication users, then
- select and then click “[here](#)” to return
- On the left hand side menu select [POTS](#)

Vega 50 Configuration

Host Name: Vega50_IAD8
 IP Address: 136.170.209.171
 User Name: admin

Unsaved & Unapplied Changes

POTS Configuration

Port Configuration							
Port ID	Enabled	nt	Caller ID	Layer 1	Hardware profile	Interfaces	Chg?
1	1	1	on	g711Alaw64k	1	====>	Modify
2	1	1	on	g711Alaw64k	1	====>	Modify
3	1	1	on	g711Alaw64k	1	====>	Modify
4	1	1	on	g711Alaw64k	1	====>	Modify
5	1	1	on	g711Alaw64k	1	====>	Modify
6	1	1	on	g711Alaw64k	1	====>	Modify
7	1	1	on	g711Alaw64k	1	====>	Modify
8	1	1	on	g711Alaw64k	1	====>	Modify
9	1	0	on	g711Alaw64k	1	====>	Modify
10	1	0	on	g711Alaw64k	1	====>	Modify

POTS Interface Profiles

[POTS Interface Profiles](#)

Advanced POTS Configuration

[Advanced POTS](#)

Save
Log off
Help
Reboot System
Apply Changes

- Select [POTS Interface Profiles](#)

POTS Interface Profiles Configuration

POTS Interface Profiles						
Profile ID	Caller ID type	Caller ID wait	DTMF dial digit	DTMF dial timeout	Line busy cause	Chg?
1	off	6000	*	10	17	Modify

Delete Add

- Select [Modify](#)

VegaStream

Host Name	Vega50_IAD8
IP Address	136.170.209.171
User Name	admin

Vega 50 Configuration

Unsaved & Unapplied Changes

Management

POTS > Profile 1

Modify Profile

Profile ID	1
Line busy cause	17
Caller ID wait	6000
Caller ID type	off
DTMF Termination Char	*
DTMF Dial Timeout	10
Authentication username prefix	NULL
Authentication username suffix	vega1
Authentication useumber prefix	NULL
Authentication useumber suffix	01
Username prefix	NULL
Username suffix	vega1
Usernumber prefix	NULL
Usernumber suffix	01

Save

Log off

Help

Reboot System

Apply Changes

Submit

Visit the VegaStream website

Internet

➤ **Configure the Authentication versions of**
 usernumber prefix and usernumber suffix

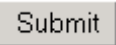
➤ select  and then click "[here](#)" to return

➤ select  ... to return to the POTS configuration page

Vega 50 Configuration

Host Name: Vega50_IAD8
 IP Address: 136.170.209.171
 User Name: admin

Unsaved & Unapplied Changes

POTS Configuration

Port ID	Enabled	nt	Caller ID	Layer 1	Hardware profile	Interfaces	Chg?
1	1	1	on	g711Alaw64k	1	====>	Modify
2	1	1	on	g711Alaw64k	1	====>	Modify
3	1	1	on	g711Alaw64k	1	====>	Modify
4	1	1	on	g711Alaw64k	1	====>	Modify
5	1	1	on	g711Alaw64k	1	====>	Modify
6	1	1	on	g711Alaw64k	1	====>	Modify
7	1	1	on	g711Alaw64k	1	====>	Modify
8	1	1	on	g711Alaw64k	1	====>	Modify
9	1	0	on	g711Alaw64k	1	====>	Modify
10	1	0	on	g711Alaw64k	1	====>	Modify

Save
 Log off
 Help
 Reboot System
 Apply Changes

POTS Interface Profiles
[POTS Interface Profiles](#)

Advanced POTS Configuration
[Advanced POTS](#)

The Authentication usernumber and password are configured on a per port basis.

In the **Port Configuration** section, for Port ID 1

- Select [Modify](#)

POTS > Port 1

Modify Port	
Port ID	1
Enable	<input checked="" type="checkbox"/>
Layer 1	g711Alaw64k
Caller ID	on
NT	1
Hardware profile	1
<input type="button" value="Submit"/>	

Interface Configuration												
Interface ID	Profile	Interface number	DN	cost	Registration enabled	Username	Useumber	Authentication username	Authentication useumber	Password	Ring Index	Chg?
1	1	06	06	1	1	port1	01	port1	01	user1	2	Modify
<input type="button" value="Delete"/>		<input type="button" value="Add"/>										

In the **Interface Configuration** section, for Interface ID 1

- Select [Modify](#)

Host Name Vega50_IAD8
IP Address 136.170.209.171
User Name admin

Unsaved & Unapplied Changes

Vega 50 Configuration

Management
Logging
Maintenance
LAN
POTS
Dial Plan
Media Channels
Tones
SIP
Users
QoS
Advanced

Save
Log off
Help
Reboot System
Apply Changes

POTS > Port 1 > Interface 1

Modify Interface

Port Index	1
Interface Profile	1
Interface ID	06
Cost	1
Ring index	2
dn	06
Username	port1
Usernumber	01

Submit

Registration

Enable	1
Authorization username	port1
Authorization usernumber	01
Password	user1

Submit

POTS Interface Profiles

Visit the VegaStream website

Internet

- Configure Authentication usernumber and Password
- select and then click ["here"](#) to return

POTS Configuration

Port Configuration							
Port ID	Enabled	nt	Caller ID	Layer 1	Hardware profile	Interfaces	Chg?
1	1	1	on	g711Alaw64k	1	===>	Modify
2	1	1	on	g711Alaw64k	1	===>	Modify
3	1	1	on	g711Alaw64k	1	===>	Modify
4	1	1	on	g711Alaw64k	1	===>	Modify
5	1	1	on	g711Alaw64k	1	===>	Modify
6	1	1	on	g711Alaw64k	1	===>	Modify
7	1	1	on	g711Alaw64k	1	===>	Modify
8	1	1	on	g711Alaw64k	1	===>	Modify
9	1	0	on	g711Alaw64k	1	===>	Modify
10	1	0	on	g711Alaw64k	1	===>	Modify

- Repeat configuring the Authentication usernumber and Password for all other Ports

8. Configure Registration

FXS:

FXS port registration provides the SIP proxy with two main pieces of information:

- “address” – the public address of the Vega port (the URL which other SIP endpoints will use to make calls to this port)
- “contact” – the URL which the proxy is to use to make the call on that port on the Vega

When a SIP call request is sent to the SIP proxy, it receives the call to a public address, it then performs a translation from the public address to the contact format, and uses the contact format to present the call to the Vega.

FXO

Typically trunking ports, like the FXO ports on this unit do not need to register with a SIP proxy. SIP registration was designed for end users to register themselves with the current local SIP proxy. Trunking ports potentially support many millions of end users (the whole of the PSTN network) and so typically the presence and capabilities of the gateways are manually configured into the SIP proxy.

For telephony to SIP calls, the SIP proxy is usually manually configured to accept calls from the FXO ports

- the interface ID on which the call arrived will be in the request URI
- where supported and enabled the caller ID will be provided in the SIP From: or RPID: header

For SIP to telephony calls the Proxy must send the call to the Vega 50 FXO with a request URI of the format `ii...t@contact_address`

- where `ii` is the interface number through which to make the call (Vega interface 06 to 13), and
- where `ttt...t` is the telephone number for the Vega to dial

In some circumstances the SIP proxy does demand that the Vega registers with it. If so, configure registration in the same way FXS registration is configured.

FXS and FXO:

The Registration format is:

```
--- address:
    Public_Address@Registration_Domain
--- contact:
    <sip:DN@Host_Name_or_IP_address_of_Vega>
```

The Vega registers twice for each physical port – once using a numeric address, and once using an alphanumeric address. Both registrations use the same contact address, so that when a call arrives, the Vega is not aware of whether the call was made using the numeric URL, or whether the call was made using the alphanumeric URL.

For the alphanumeric registration, `Public_Address` is made up of `Username_prefix`, `Username`, and `Username_suffix`; the prefix and suffix being per unit values and the `Username` being per port values.

For the numeric registration, `Public_Address` is made up of `Usernumber_prefix`, `Usernumber`, and `Usernumber_suffix`; the prefix and suffix being per unit values and the `Usernumber` being per port values.

The registration details are configurable using the Command Line Interface or the web browser interface.

Alphanumeric registration (name registration) uses configurable entries:

- `Username_prefix` ... per unit value
- `Username` ... per port value
- `Username_suffix` ... per unit value
- Local Domain (`Registration_Domain`) ... already configured in section 6
- `DN` ... per port value
- `Host_Name_or_IP_address_of_Vega` ... set up by DHCP or in section 4

Name Registration message format:

```
--- address:
    Username_prefixUsernameUsername_suffix@Registration_Domain
--- contact:
    <sip:DN@Host_Name_or_IP_address_of_Vega>
```

Numeric registration uses configurable entries:

- `Usernumber_prefix` ... per unit value
- `Usernumber` ... per port value
- `Usernumber_suffix` ... per unit value
- Local Domain (`Registration_Domain`) ... already configured in section 6
- `DN` ... per port value
- `Host_Name_or_IP_address_of_Vega` ... set up by DHCP or in section 4

Number Registration message format:

```
--- address:
    Usernumber_prefixUsernumberUsernumber_suffix@Registration_Domain
--- contact:
    <sip:DN@Host_Name_or_IP_address_of_Vega>
```

e.g. to set up registration so that the Vega registers:

Port 1

```
--- address:
    Unit1Port1Vega50@Registration_Domain
--- contact:
    <sip:06@Host_Name_or_IP_address_of_Vega>
--- address:
    55501@Registration_Domain
```

```
--- contact:
    <sip:06@Host_Name_or_IP_address_of_Vega>
    .
    .
    .
Port 8 Name
--- address:
    Unit1Port8Vega50@Registration_Domain
--- contact:
    <sip:13@Host_Name_or_IP_address_of_Vega>
--- address:
    55508@Registration_Domain
--- contact:
    <sip:13@Host_Name_or_IP_address_of_Vega>
```

- On the left hand side menu select [SIP](#)
- Scroll down to the **Registration** section

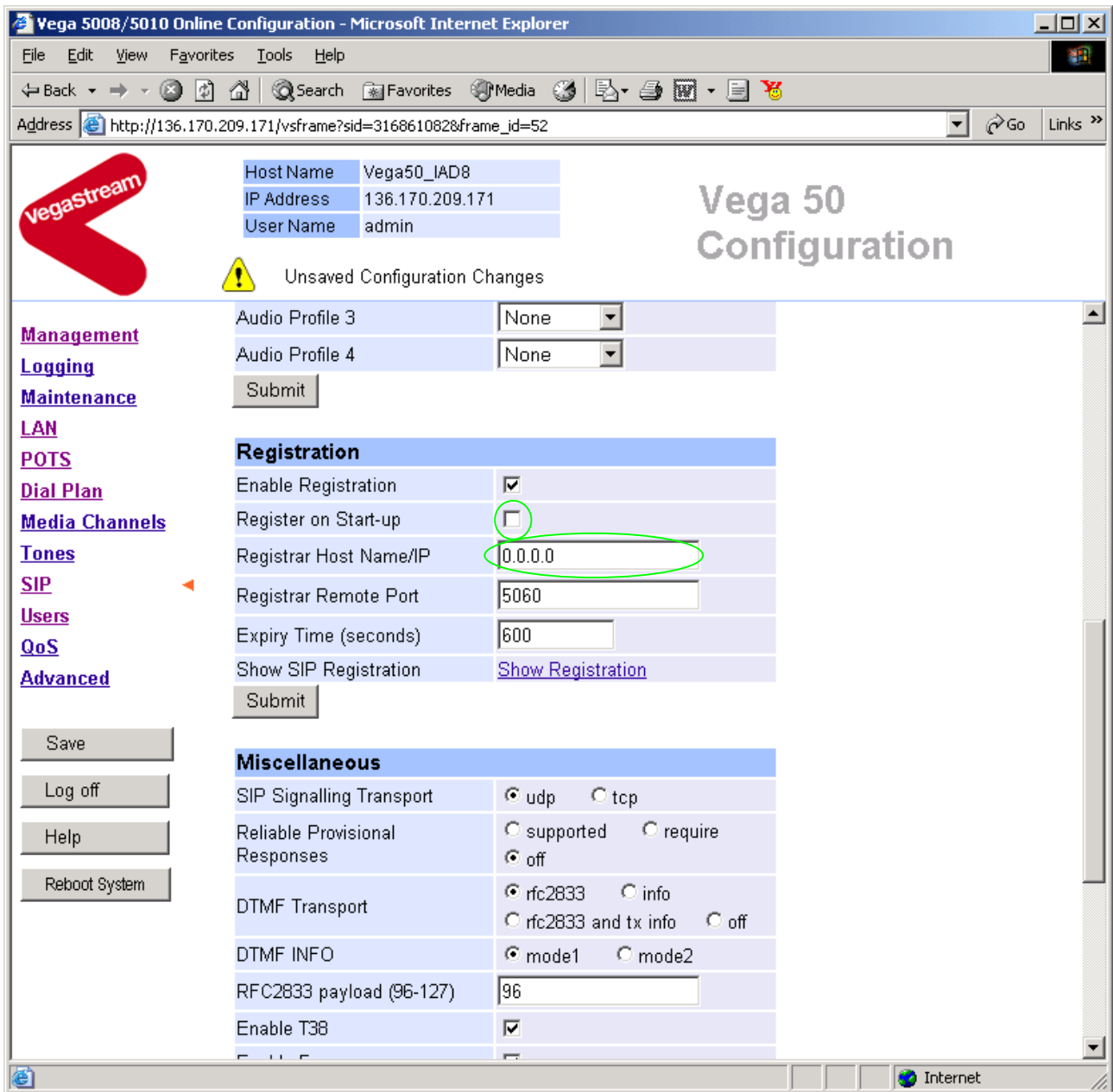

- Tick Register on Start-up

This will cause the Vega to register with the proxy every time it is powered on or re-booted

- set Registrar Host Name/IP =

IP_or_DNS_name_of_SIP_registrar_or_machi
ne_proxying_for_the_regitrar

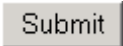
- select  and then click **“here”** to return

- On the left hand side menu select [POTS](#)

Host Name Vega50_IAD8
IP Address 136.170.209.171
User Name admin

Vega 50 Configuration

Unsaved & Unapplied Changes

Management
Logging
Maintenance
LAN
POTS
Dial Plan
Media Channels
Tones
SIP
Users
QoS
Advanced

Save
Log off
Help
Reboot System
Apply Changes

POTS Configuration

Port ID	Enabled	nt	Caller ID	Layer 1	Hardware profile	Interfaces	Chg?
1	1	1	on	g711Alaw64k	1	====>	Modify
2	1	1	on	g711Alaw64k	1	====>	Modify
3	1	1	on	g711Alaw64k	1	====>	Modify
4	1	1	on	g711Alaw64k	1	====>	Modify
5	1	1	on	g711Alaw64k	1	====>	Modify
6	1	1	on	g711Alaw64k	1	====>	Modify
7	1	1	on	g711Alaw64k	1	====>	Modify
8	1	1	on	g711Alaw64k	1	====>	Modify
9	1	0	on	g711Alaw64k	1	====>	Modify
10	1	0	on	g711Alaw64k	1	====>	Modify

POTS Interface Profiles
[POTS Interface Profiles](#)

Advanced POTS Configuration
[Advanced POTS](#)

- Select [POTS Interface Profiles](#)

POTS Interface Profiles Configuration

Profile ID	Caller ID type	Caller ID wait	DTMF dial digit	DTMF dial timeout	Line busy cause	Chg?
1	off	6000	*	10	17	Modify

Delete Add

- Select [Modify](#)

Vega 5008/5010 Online Configuration - Microsoft Internet Explorer

Address: http://136.170.209.171/vsframe?sid=493765280&frame_id=76

VegaStream

Host Name	Vega50_IAD8
IP Address	136.170.209.171
User Name	admin

Vega 50 Configuration

Unsaved & Unapplied Changes

Management
Logging
Maintenance
LAN
POTS
Dial Plan
Media Channels
Tones
SIP
Users
QoS
Advanced

POTS > Profile 1



Modify Profile

Profile ID	1
Line busy cause	17
Caller ID wait	6000
Caller ID type	off
DTMF Termination Char	*
DTMF Dial Timeout	10
Authentication username prefix	NULL
Authentication username suffix	vega1
Authentication usernumber prefix	NULL
Authentication usernumber suffix	01
Username prefix	NULL
Username suffix	vega1
Usernumber prefix	NULL
Usernumber suffix	01

Save
Log off
Help
Reboot System
Apply Changes

Submit

Internet

- Set Username prefix = Unit1
- Set Username suffix = Vega50
- Set Usernumber prefix = 555
- Set Usernumber suffix = NULL *(NULL specifies no suffix; NULL must be in capitals)*
- select  and then click "[here](#)" to return
- select  ... to return to the POTS configuration page

Host Name Vega50_IAD8
IP Address 136.170.209.171
User Name admin

Vega 50 Configuration

Unsaved & Unapplied Changes

Management
Logging
Maintenance
LAN
POTS
Dial Plan
Media Channels
Tones
SIP
Users
QoS
Advanced

POTS Configuration

Port ID	Enabled	nt	Caller ID	Layer 1	Hardware profile	Interfaces	Chg?
1	1	1	on	g711Alaw64k	1	====>	Modify
2	1	1	on	g711Alaw64k	1	====>	Modify
3	1	1	on	g711Alaw64k	1	====>	Modify
4	1	1	on	g711Alaw64k	1	====>	Modify
5	1	1	on	g711Alaw64k	1	====>	Modify
6	1	1	on	g711Alaw64k	1	====>	Modify
7	1	1	on	g711Alaw64k	1	====>	Modify
8	1	1	on	g711Alaw64k	1	====>	Modify
9	1	0	on	g711Alaw64k	1	====>	Modify
10	1	0	on	g711Alaw64k	1	====>	Modify

POTS Interface Profiles
[POTS Interface Profiles](#)

Advanced POTS Configuration
[Advanced POTS](#)

Save
Log off
Help
Reboot System
Apply Changes

The username, user number and password are configured on a per port basis.

In the **Port Configuration** section, for Port ID 1

- Select [Modify](#)

POTS > Port 1

Modify Port	
Port ID	1
Enable	<input checked="" type="checkbox"/>
Layer 1	g711Alaw64k
Caller ID	on
NT	1
Hardware profile	1
<input type="button" value="Submit"/>	

Interface Configuration												
Interface ID	Profile	Interface number	DN	cost	Registration enabled	Username	Usernumber	Authentication username	Authentication usernumber	Password	Ring Index	Chg?
1	1	06	06	1	1	0	0	port1	01	user1	2	Modify
<input type="button" value="Delete"/>		<input type="button" value="Add"/>										

In the **Interface Configuration** section, for Interface ID 1

- Select [Modify](#)

Vega 5008/5010 Online Configuration - Microsoft Internet Explorer

Address: http://136.170.209.171/vsframe?sid=493765280&frame_id=76

VegaStream

Host Name: Vega50_IAD8
IP Address: 136.170.209.171
User Name: admin

Unsaved & Unapplied Changes

Vega 50 Configuration

Management
Logging
Maintenance
LAN
POTS
Dial Plan
Media Channels
Tones
SIP
Users
QoS
Advanced

POTS > Port 1 > Interface 1

Modify Interface

Port Index	1
Interface Profile	1
Interface ID	06
Cost	1
Ring index	2
dn	06
Username	0
Usernumber	0

Save
Log off
Help
Reboot System
Apply Changes

Registration

Enable	1
Authorization username	port1
Authorization usenumber	01
Password	user1

Submit

POTS Interface Profiles

Done Internet

- check that DN = 06
- set Username = Port1
- set Usernumber = 01
- select and then click "[here](#)" to return

Return to this page

Host Name Vega50_IAD8
IP Address 136.170.209.171
User Name admin

Vega 50 Configuration

Unsaved & Unapplied Changes

Management
Logging
Maintenance
LAN
POTS
Dial Plan
Media Channels
Tones
SIP
Users
QoS
Advanced

Save
Log off
Help
Reboot System
Apply Changes

POTS > Port 1 > Interface 1

Modify Interface

Port Index	1
Interface Profile	1
Interface ID	06
Cost	1
Ring index	2
dn	06
Username	0
Usernumber	0

Submit

Registration

Enable	1
Authorization username	port1
Authorization usernumber	01
Password	user1

Submit

POTS Interface Profiles

- check that `Enable` in the **Registration** section is ticked or set to 1
- select `Submit` and then click "[here](#)" to return

POTS Configuration

Port Configuration							
Port ID	Enabled	nt	Caller ID	Layer 1	Hardware profile	Interfaces	Chg?
1	1	1	on	g711Alaw64k	1	====>	Modify
2	1	1	on	g711Alaw64k	1	====>	Modify
3	1	1	on	g711Alaw64k	1	====>	Modify
4	1	1	on	g711Alaw64k	1	====>	Modify
5	1	1	on	g711Alaw64k	1	====>	Modify
6	1	1	on	g711Alaw64k	1	====>	Modify
7	1	1	on	g711Alaw64k	1	====>	Modify
8	1	1	on	g711Alaw64k	1	====>	Modify
9	1	0	on	g711Alaw64k	1	====>	Modify
10	1	0	on	g711Alaw64k	1	====>	Modify

Repeat for Port ID 2:

- check that DN = 07
- set Username = Port2
- check Usernumber = 02
- check that Enable registration is ticked or set to 1

Repeat for Port ID 3:

- check that DN = 08
- set Username = Port3
- check Usernumber = 03
- check that Enable registration is ticked or set to 1

Etc up to:

Repeat for Port ID 8:

- check that DN = 13
- set Username = Port8
- check Usernumber = 08
- check that Enable registration is ticked or set to 1

Repeat for Port Ids 9 and 10 if the FXO ports need to register as well.

When a remote caller attempts to contact any of the Name or Number URL addresses the SIP registrar will look up the registration information and will translate the URL, causing the Vega to be called at the appropriate contact address (DN@Host_Name_or_IP_address_of_Vega).

9. Configure POTS parameters

No specific configuration is required for the FXS ports.

For the FXO ports it is necessary to configure the Vega to recognise the cadence of the ring tone that it will receive to indicate that there is a new call for it, also the impedance of the FXO interface.

Configuring Ring Cadence Detection for FXO ports

The Vega FXOports are alerted to new telephony calls arriving by the PBX or CO switch presenting ringing voltage to the Vega. The Vega needs to have parameters adjusted to configure the detector for the ring tone(s) it is going to be presented with.

Now configure the FXO ring cadence detector so that it detects incoming ring cadences correctly:

- On the left hand side menu select [POTS](#)

Host Name Vega50_IAD8
 IP Address 136.170.209.171
 User Name admin

Vega 50 Configuration

Unsaved & Unapplied Changes

Management
 Logging
 Maintenance
 LAN
 POTS
 Dial Plan
 Media Channels
 Tones
 SIP
 Users
 QoS
 Advanced

POTS Configuration

Port ID	Enabled	nt	Caller ID	Layer 1	Hardware profile	Interfaces	Chg?
1	1	1	on	g711Alaw64k	1	====>	Modify
2	1	1	on	g711Alaw64k	1	====>	Modify
3	1	1	on	g711Alaw64k	1	====>	Modify
4	1	1	on	g711Alaw64k	1	====>	Modify
5	1	1	on	g711Alaw64k	1	====>	Modify
6	1	1	on	g711Alaw64k	1	====>	Modify
7	1	1	on	g711Alaw64k	1	====>	Modify
8	1	1	on	g711Alaw64k	1	====>	Modify
9	1	0	on	g711Alaw64k	1	====>	Modify
10	1	0	on	g711Alaw64k	1	====>	Modify

Save
 Log off
 Help
 Reboot System
 Apply Changes

POTS Interface Profiles
[POTS Interface Profiles](#)

Advanced POTS Configuration
[Advanced POTS](#)

- Select [Advanced POTS](#)
- Scroll down to the **FXO Configuration** section

Host Name: Vega50_IAD8
 IP Address: 136.170.209.171
 User Name: admin

Vega 50 Configuration

Unsaved & Unapplied Changes

Ring Generation Parameters

Del?	ID	Name	Fre-quency	Repeat	Ring1 On	Ring1 Off	Ring2 On	Ring2 Off	Ring3 On	Ring3 Off	Chg?
<input type="checkbox"/>	1	External	50	1	400	200	400	2000	0	500	Modify
<input type="checkbox"/>	2	Internal	50	0	2000	4000	2000	4000	0	500	Modify
<input type="checkbox"/>	3	bellcore-r1	20	1	400	400	900	400	400	3500	Modify

Delete Add

FXS Configuration

Hardware Profile Configuration

Profile ID	Hookflash Debounce Time	Loop Current Break	Loop Current Delay	Loop Current Time	Hookflash Time	Line Reversal	Impedance	Chg?
1	70	off	9000	300	200	0	default	Modify

Delete Add

FXO Configuration

Hardware Profile Configuration

Profile ID	Loop Current Detect	Loop Current Time	Hookflash Time	Early Line Seize	Early Line Seize Time	Line Reversal Detect	Force Disconnects	DTMF Holdoff Time	Ringback Present	Impedance	Port Release Delay	Port Not Released Cause	More	Chg?
1	0	300	200	0	30	0	1	200	1	CTR21	0	34	===>	Modify

Delete Add

Save
 Log off
 Help
 Reboot System
 Apply Changes

- In the FXO Configuration **Hardware Profile Configuration** section select [Modify](#)
- Scroll down to the **FXO ring-detection parameters** section

Vega 5008/5010 Online Configuration - Microsoft Internet Explorer

Address: http://136.170.209.171/vsframe?sid=493765280&frame_id=32

VegaStream

Host Name: Vega50_IAD8
 IP Address: 136.170.209.171
 User Name: admin

Vega 50 Configuration

 Unsaved & Unapplied Changes

Management
Logging
Maintenance
LAN
POTS
Dial Plan
Media Channels
Tones
SIP
Users
QoS
Advanced

Early Line Seize Timeout (s)	30
Line Reversal Detection	<input type="checkbox"/>
Line Reversal Debounce Time (ms)	50
Force Disconnects	<input checked="" type="checkbox"/>
DTMF Hold-off Time (ms)	200
Line Reversal Sample Delay (ms)	50
Ringback Present	<input checked="" type="checkbox"/>
Impedance	CTR21
Port Release Delay (s)	0
Port Not Released Cause Code	34

Submit

Save
 Log off
 Help
 Reboot System
 Apply Changes

FXO ring-detection parameters

Ring Cadence Delta	14
Ring Cadence Threshold	56
Ring Cadence Limit	200

Submit

Configure Ring Detect Values



➤ Select **Configure Ring Detect Values**

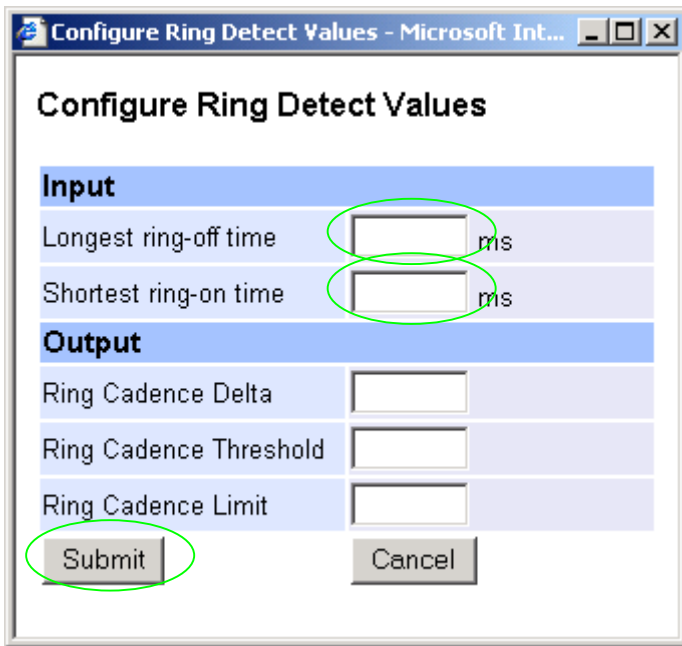

- Set Longest ring-off time = length of longest silence in the incoming ringing voltage cadence
- Set Shortest ring-on time = length of shortest ring in the incoming ringing voltage cadence
- select

Table 1 lists the standard values to use in the UK and USA.

Table 1. Ring tones parameters

	Country	UK	USA
Ring tone values	Longest silence	2000ms	4000ms
	Shortest ring	400ms	2000ms

Host Name Vega50_IAD8
IP Address 136.170.209.171
User Name admin

Vega 50 Configuration

Unsaved & Unapplied Changes

Management
Logging
Maintenance
LAN
POTS
Dial Plan
Media Channels
Tones
SIP
Users
QoS
Advanced

Save
Log off
Help
Reboot System
Apply Changes

Early Line Seize Timeout (s) 30
Line Reversal Detection
Line Reversal Debounce Time (ms) 50
Force Disconnects
DTMF Hold-off Time (ms) 200
Line Reversal Sample Delay (ms) 50
Ringback Present
Impedance CTR21
Port Release Delay (s) 0
Port Not Released Cause Code 34

Submit

FXO ring-detection parameters

Ring Cadence Delta 12
Ring Cadence Threshold 320
Ring Cadence Limit 400

Submit Configure Ring Detect Values

➤ select  and then click "[here](#)" to return

Now configure the interface impedance

Vega 5008/5010 Online Configuration - Microsoft Internet Explorer

Address: http://136.170.209.171/vsframe?sid=493765280&frame_id=32

VegaStream

Host Name: Vega50_IAD8
 IP Address: 136.170.209.171
 User Name: admin

Vega 50 Configuration

⚠ Unsaved & Unapplied Changes

Management

- Logging
- Maintenance
- LAN
- POTS
- Dial Plan
- Media Channels
- Tones
- SIP
- Users
- QoS
- Advanced

Save
 Log off
 Help
 Reboot System
 Apply Changes

Ring Generation Parameters

Del?	ID	Name	Fre-quency	Repeat	Ring1 On	Ring1 Off	Ring2 On	Ring2 Off	Ring3 On	Ring3 Off	Chg?
<input type="checkbox"/>	1	External	50	1	400	200	400	2000	0	500	Modify
<input type="checkbox"/>	2	Internal	50	0	2000	4000	2000	4000	0	500	Modify
<input type="checkbox"/>	3	bellcore-r1	20	1	400	400	900	400	400	3500	Modify

Delete Add

FXS Configuration

Hardware Profile Configuration

Profile ID	Hookflash Debounce Time	Loop Current Break	Loop Current Delay	Loop Current Time	Hookflash Time	Line Reversal	Impedance	Chg?
1	70	off	9000	300	200	0	default	Modify

Delete Add

FXO Configuration

Hardware Profile Configuration

Profile ID	Loop Current Detect	Loop Current Time	Hookflash Time	Early Line Seize	Early Line Seize Time	Line Reversal Detect	Force Disconnects	DTMF Holdoff Time	Ringback Present	Impedance	Port Release Delay	Port Not Released Cause	More	Chg?
1	0	300	200	0	30	0	1	200	1	CTR21	0	34	===>	Modify

Delete Add

- In the FXO Configuration **Hardware Profile Configuration** section select [Modify](#)

Host Name Vega50_IAD8
IP Address 136.170.209.171
User Name admin

Vega 50 Configuration

Unsaved & Unapplied Changes

Management
Logging
Maintenance
LAN
POTS
Dial Plan
Media Channels
Tones
SIP
Users
QoS
Advanced

POTS > Advanced > FXO > 1

FXO parameters

Loop Current Detect	<input type="checkbox"/>
Loop Current Time	300
Hook Flash Time (ms)	200
Early Line Seize	<input type="checkbox"/>
Early Line Seize Time	30
Early Line Seize Timeout (s)	30
Line Reversal Detection	<input type="checkbox"/>
Line Reversal Debounce Time (ms)	50
Force Disconnects	<input checked="" type="checkbox"/>
DTMF Hold-off Time (ms)	200
Line Reversal Sample Delay (ms)	50
Ringback Present	<input checked="" type="checkbox"/>
Impedance	CTR21
Port Release Delay (s)	0
Port Not Released Cause Code	34

Submit

Save
Log off
Help
Reboot System
Apply Changes

- In the **FXO parameters** section, select the appropriate Impedance for the lines that the Vega FXO ports are to be connected to:
 - CTR21 (typically Europe)
 - 600R (typically US)
 - 900R
 - default

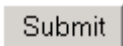
- select  and then click "[here](#)" to return

10. Configure pointer to CD ROM documentation

- On the left hand side menu select [LAN](#)
- Scroll to the bottom of the screen

Host Name Vega50_IAD8
IP Address 136.170.209.171
User Name admin

Vega 50 Configuration

Unsaved & Unapplied Changes

Management
Logging
Maintenance
LAN
POTS
Dial Plan
Media Channels
Tones
SIP
Users
QoS
Advanced

Subnet Mask DHCP defined
Domain Name Server DHCP defined Use DHCP
Default Gateway DHCP defined Use DHCP
TFTP Server DHCP defined Use DHCP
Network Time Server DHCP defined Use DHCP
FTP Server 0.0.0.0
NTP Offset (hhmm) 0000
NTP Poll Interval 0

Physical Layer Configuration
Full Duplex
Ethernet Type 100baseTX
QoS profile 1

Submit

Lan Hosts

ID	Name	IP	Chg?
1	loopback	127.0.0.1	Modify

Delete Add

Advanced LAN Configuration
[Advanced LAN](#)

- Select [Advanced LAN](#)

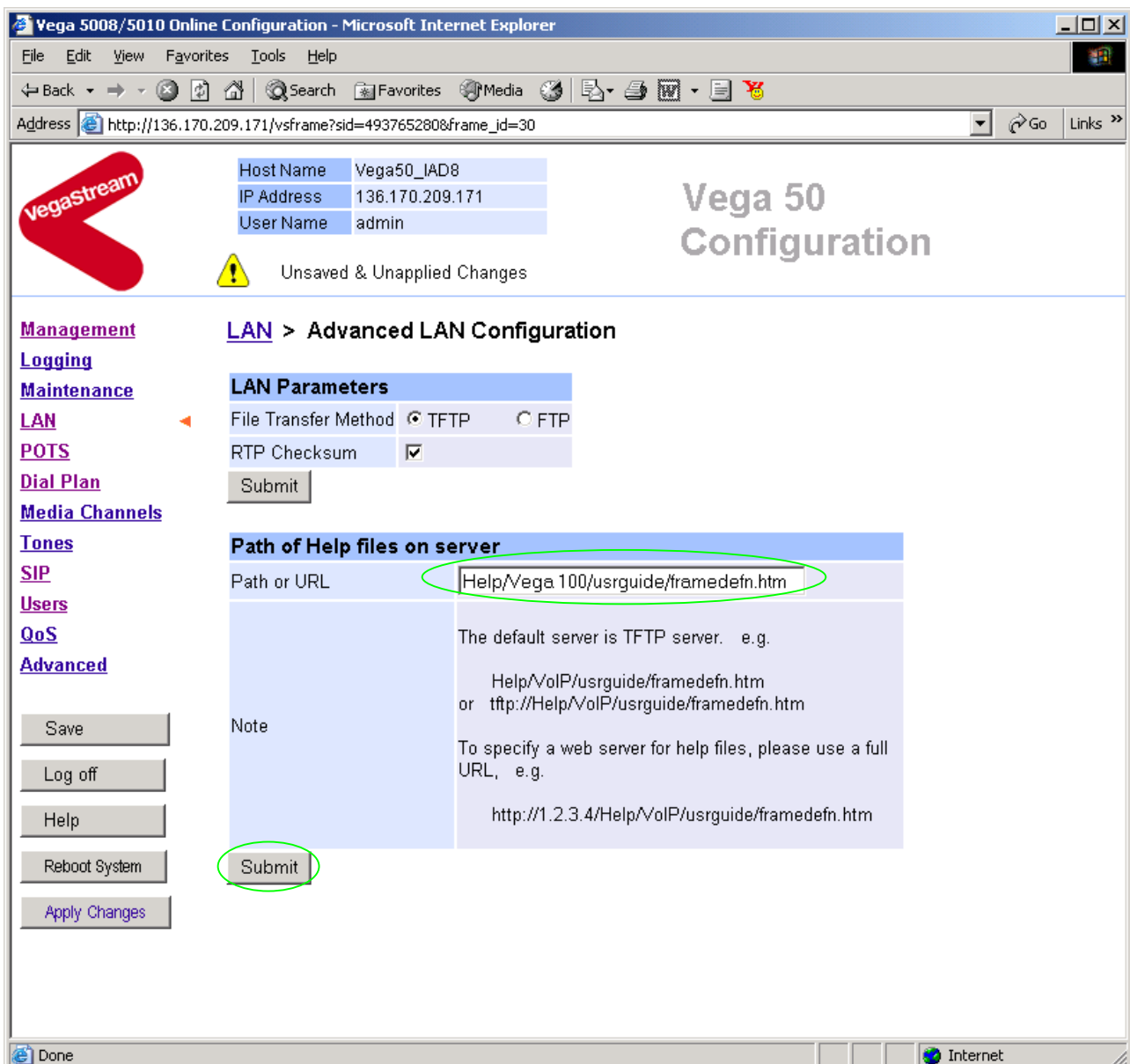

To configure for operation using the CD in the local PC CD-ROM drive,

- Set Path or URL = D: /Content/help/v50_8fxs_2fxo_s_R5.htm
- ... N.B. use forward slashes “/” not back slashes “\”.

(Substitute appropriate drive letter if D: is not the CD-ROM)

- select and then click “[here](#)” to return

11. Save Changes

The changes to the configuration must be saved and activated. This is carried out as follows:

- Select 

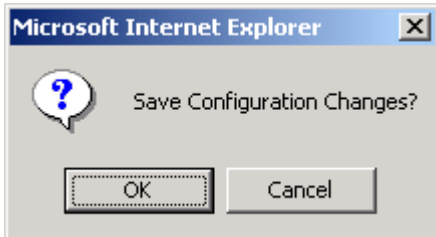

- Select  and after the configuration has been saved click "[here](#)" to return

- Select 

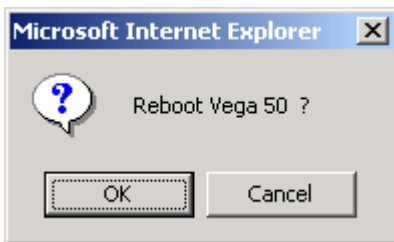

- Select 

The Vega will reboot and once back on-line, it will be ready to take its first call.

12. Archive Vega Configuration

Once configured it is recommended that the configuration is archived to an external server.

To do this check that the tftp address is configured to point to a tftp server (in the [LAN](#) page), then on the left hand side menu select [Advanced](#), and scroll to the CLI Command section:

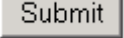

The screenshot shows a web interface for the CLI Command section. It features a blue header bar with the text 'CLI Command'. Below the header is a white text input field, and to its right is a grey button labeled 'Submit'.

- in the text entry box type “PUT tftp:initial_cfg.txt”. Select .

This will send all the configuration parameters to the tftp server and save them as the file “initial_cfg.txt”. (Note: you may want to choose a unique name rather than “initial_cfg.txt”, especially if you are configuring more than 1 unit).

The Vega configuration can be archived to an ftp server instead of a tftp server by configuring the ftp server address in the [LAN](#) page and then typing the CLI command “PUT FTP:initial_cfg.txt”. (Again a unique name can be used in place of “initial_cfg.txt”)

If the ftp server requires a login username and password configure the following:

- set _advanced.lan.ftp.anonymous_login=0
- set _advanced.lan.ftp.username=<ftp username>
- set _advanced.lan.ftp._password-<ftp password>

13. Technical Support

Support information can be found on the VegaStream Support web site www.VegaAssist.com

If you require help from VegaStream support personnel, please use the serial interface or telnet into the unit, log in and then type:

- show support
- sip monitor on
- log display on

Carry out the interaction you want explained, then copy the information provided by the Vega and e-mail it to support@VegaStream.com together with your question.

Notes:

1. If the screens do not appear as indicated, check that Java is enabled on your web browser (Tools>internet options>Security, select internet and custom level and configure Microsoft VM Java permissions and Scripting parameters as indicated below.

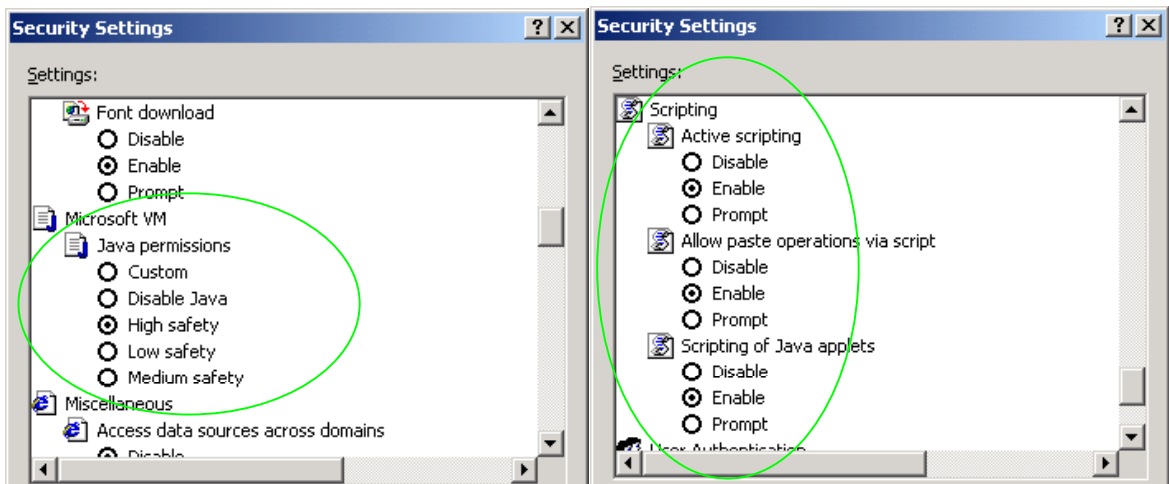

2. Where there are multiple sections – each with a **Submit** button – entries must be made to one section at a time, and those entries confirmed by the **Submit** button before the next section is altered. Each **Submit** button only confirms entries for its own section. Any changes in other sections will be discarded when the **Submit** is pressed.
3. Loss of audio mid call – consider reducing the selection of available codecs (see section 1.5). Some equipment, when presented with multiple codecs, may try and switch codec mid-call. Vegas do not support changing codec type mid-call.
4. Mismatched audio codecs. Use SIP monitor on to identify this. If the codecs of the endpoints are mismatched this will be reported as error 606 “No matching media”. To rectify, enable the appropriate audio codec (see section 1.5).
5. Outbound calls from the Vega send the INVITE to “Default Proxy Host Name/IP” with the request line: “INVITE sip: <dest TEL:>@Default Proxy Host Name/IP”.

Contact Details

Email: support@vegastream.com

Web: <http://www.vegastream.com>

EMEA Office

VegaStream Limited

Berkshire Court

Western Road

Bracknell

Berks RG12 1RE

UK

+44 (0) 1344 784900

USA Office

VegaStream Inc.

3701 FAU Boulevard

Suite 200

Boca Raton

FL 33431

USA

+1 561 995 2300